

PMEGxx10EH/EJ series

1 A very low V_F MEGA Schottky barrier rectifiers

Rev. 03 — 11 April 2005

Product data sheet

1. Product profile

1.1 General description

Planar Maximum Efficiency General Application (MEGA) Schottky barrier rectifiers.

Table 1: Product overview

Type number	Package		Configuration
	Philips	JEITA	
PMEG2010EH	SOD123F	-	single diode
PMEG3010EH			
PMEG4010EH			
PMEG2010EJ	SOD323F	SC-90	single diode
PMEG3010EJ			
PMEG4010EJ			

1.2 Features

- Forward current: ≤ 1 A
- Very low forward voltage

1.3 Applications

- Low voltage rectification
- Inverse polarity protection
- High efficiency DC-to-DC conversion
- Low power consumption applications

1.4 Quick reference data

Table 2: Quick reference data



Symbol	Parameter	Conditions	Min	Typ	Max	Unit
I_F	forward current	$T_{sp} \leq 55$ °C	-	-	1	A
V_R	reverse voltage					
	PMEG2010EH, PMEG2010EJ		-	-	20	V
	PMEG3010EH, PMEG3010EJ		-	-	30	V
	PMEG4010EH, PMEG4010EJ		-	-	40	V
V_F	forward voltage	$I_F = 1000$ mA [1]				
	PMEG2010EH, PMEG2010EJ		-	420	500	mV
	PMEG3010EH, PMEG3010EJ		-	450	560	mV
	PMEG4010EH, PMEG4010EJ		-	540	640	mV

[1] Pulse test: $t_p \leq 300$ μ s; $\delta \leq 0.02$.

PHILIPS

2. Pinning information

Table 3: Pinning

Pin	Description	Simplified outline	Symbol
1	cathode	 001aab540	 sym001
2	anode		

[1] The marking bar indicates the cathode.

3. Ordering information

Table 4: Ordering information

Type number	Package		
	Name	Description	Version
PMEG2010EH	-	plastic surface mounted package; 2 leads	SOD123F
PMEG3010EH			
PMEG4010EH			
PMEG2010EJ	SC-90	plastic surface mounted package; 2 leads	SOD323F
PMEG3010EJ			
PMEG4010EJ			

4. Marking

Table 5: Marking codes

Type number	Marking code
PMEG2010EH	A9
PMEG3010EH	AA
PMEG4010EH	AB
PMEG2010EJ	AH
PMEG3010EJ	AK
PMEG4010EJ	AL

5. Limiting values

Table 6: Limiting values

In accordance with the Absolute Maximum Rating System (IEC 60134).

Symbol	Parameter	Conditions	Min	Max	Unit
V_R	reverse voltage				
		PMEG2010EH, PMEG2010EJ	-	20	V
		PMEG3010EH, PMEG3010EJ	-	30	V
		PMEG4010EH, PMEG4010EJ	-	40	V
I_F	forward current	$T_{sp} \leq 55\text{ °C}$	-	1	A
I_{FRM}	repetitive peak forward current	$t_p \leq 1\text{ ms}$; $\delta \leq 0.25$	-	7	A
I_{FSM}	non-repetitive peak forward current	square wave; $t_p = 8\text{ ms}$	-	9	A
P_{tot}	total power dissipation	$T_{amb} \leq 25\text{ °C}$			
		SOD123F	[1] -	375	mW
			[2] -	830	mW
		SOD323F	[1] -	350	mW
		[2] -	830	mW	
T_j	junction temperature		-	150	°C
T_{amb}	ambient temperature		-65	+150	°C
T_{stg}	storage temperature		-65	+150	°C

[1] Device mounted on an FR4 Printed-Circuit Board (PCB), single-sided copper, tin-plated and standard footprint.

[2] Device mounted on an FR4 PCB, single-sided copper, tin-plated, mounting pad for cathode 1 cm².

6. Thermal characteristics

Table 7: Thermal characteristics

Symbol	Parameter	Conditions	Min	Typ	Max	Unit
$R_{th(j-a)}$	thermal resistance from junction to ambient	in free air	[1]			
		SOD123F	[2] -	-	330	K/W
			[3] -	-	150	K/W
		SOD323F	[2] -	-	350	K/W
			[3] -	-	150	K/W
	$R_{th(j-sp)}$	thermal resistance from junction to solder point				
		SOD123F	-	-	60	K/W
		SOD323F	-	-	55	K/W

[1] Schottky barrier rectifier thermal run-away has to be considered, as in some applications the reverse power losses P_R are a significant part of the total power losses. Nomograms for determining the reverse power losses P_R and $I_{F(AV)}$ rating are available on request.

[2] Device mounted on an FR4 PCB, single-sided copper, tin-plated and standard footprint.

[3] Device mounted on an FR4 PCB, single-sided copper, tin-plated, mounting pad for cathode 1 cm².

7. Characteristics

Table 8: Characteristics

 $T_{amb} = 25^\circ\text{C}$ unless otherwise specified.

Symbol	Parameter	Conditions	Min	Typ	Max	Unit	
V_F	forward voltage					[1]	
	PMEG2010EH, PMEG2010EJ	$I_F = 0.1\text{ mA}$	-	90	130	mV	
		$I_F = 1\text{ mA}$	-	150	190	mV	
		$I_F = 10\text{ mA}$	-	210	240	mV	
		$I_F = 100\text{ mA}$	-	280	330	mV	
		$I_F = 500\text{ mA}$	-	355	390	mV	
		$I_F = 1000\text{ mA}$	-	420	500	mV	
	PMEG3010EH, PMEG3010EJ	$I_F = 0.1\text{ mA}$	-	90	130	mV	
		$I_F = 1\text{ mA}$	-	150	200	mV	
		$I_F = 10\text{ mA}$	-	215	250	mV	
		$I_F = 100\text{ mA}$	-	285	340	mV	
		$I_F = 500\text{ mA}$	-	380	430	mV	
		$I_F = 1000\text{ mA}$	-	450	560	mV	
	PMEG4010EH, PMEG4010EJ	$I_F = 0.1\text{ mA}$	-	95	130	mV	
		$I_F = 1\text{ mA}$	-	155	210	mV	
		$I_F = 10\text{ mA}$	-	220	270	mV	
		$I_F = 100\text{ mA}$	-	295	350	mV	
		$I_F = 500\text{ mA}$	-	420	470	mV	
		$I_F = 1000\text{ mA}$	-	540	640	mV	
	I_R	reverse current					
		PMEG2010EH, PMEG2010EJ	$V_R = 10\text{ V}$	-	15	40	μA
$V_R = 20\text{ V}$			-	40	200	μA	
PMEG3010EH, PMEG3010EJ		$V_R = 10\text{ V}$	-	12	30	μA	
		$V_R = 30\text{ V}$	-	40	150	μA	
PMEG4010EH, PMEG4010EJ		$V_R = 10\text{ V}$	-	7	20	μA	
		$V_R = 40\text{ V}$	-	30	100	μA	
C_d		diode capacitance	$V_R = 1\text{ V};$ $f = 1\text{ MHz}$				
		PMEG2010EH, PMEG2010EJ		-	66	80	pF
		PMEG3010EH, PMEG3010EJ		-	55	70	pF
	PMEG4010EH, PMEG4010EJ		-	43	50	pF	

[1] Pulse test: $t_p \leq 300\ \mu\text{s}$; $\delta \leq 0.02$.

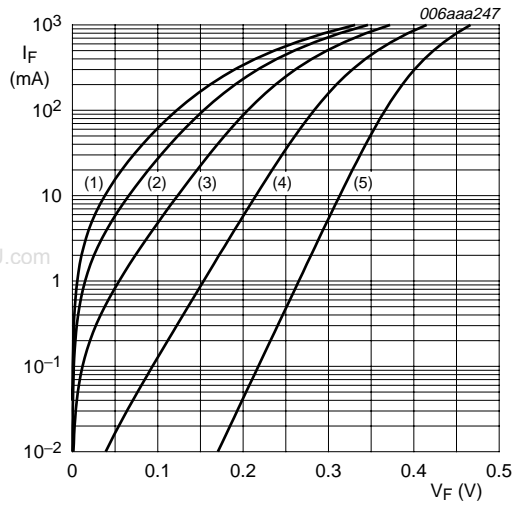

- (1) $T_{amb} = 150\text{ °C}$
- (2) $T_{amb} = 125\text{ °C}$
- (3) $T_{amb} = 85\text{ °C}$
- (4) $T_{amb} = 25\text{ °C}$
- (5) $T_{amb} = -40\text{ °C}$

Fig 1. PMEG2010EH, PMEG2010EJ: Forward current as a function of forward voltage; typical values

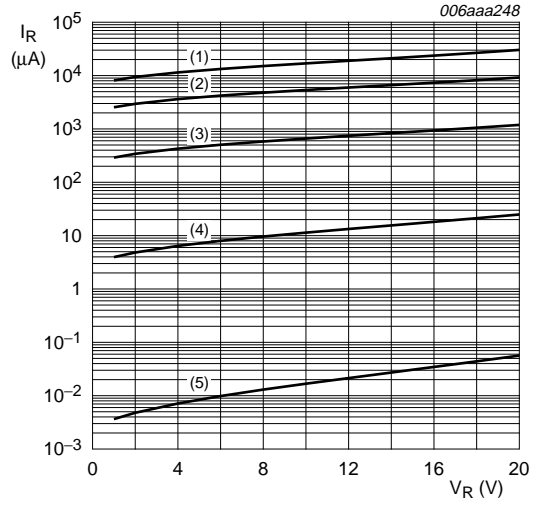

- (1) $T_{amb} = 150\text{ °C}$
- (2) $T_{amb} = 125\text{ °C}$
- (3) $T_{amb} = 85\text{ °C}$
- (4) $T_{amb} = 25\text{ °C}$
- (5) $T_{amb} = -40\text{ °C}$

Fig 2. PMEG2010EH, PMEG2010EJ: Reverse current as a function of reverse voltage; typical values

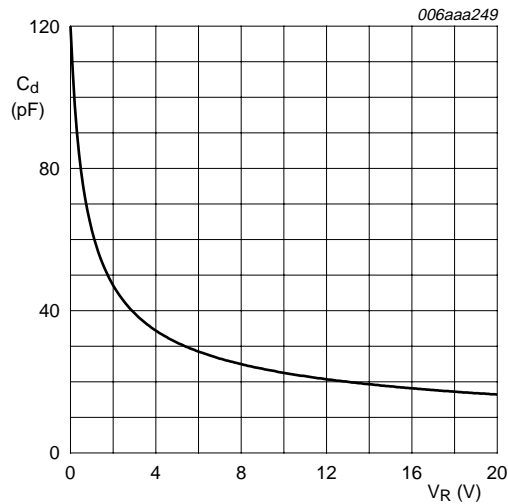

$T_{amb} = 25\text{ °C}; f = 1\text{ MHz}$

Fig 3. PMEG2010EH, PMEG2010EJ: Diode capacitance as a function of reverse voltage; typical values

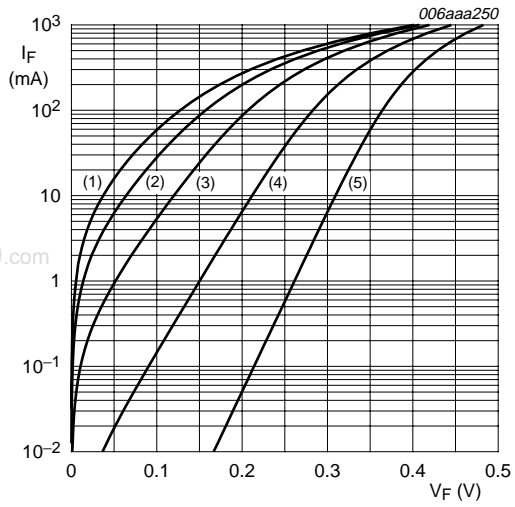

- (1) $T_{amb} = 150\text{ °C}$
- (2) $T_{amb} = 125\text{ °C}$
- (3) $T_{amb} = 85\text{ °C}$
- (4) $T_{amb} = 25\text{ °C}$
- (5) $T_{amb} = -40\text{ °C}$

Fig 4. PMEG3010EH, PMEG3010EJ: Forward current as a function of forward voltage; typical values

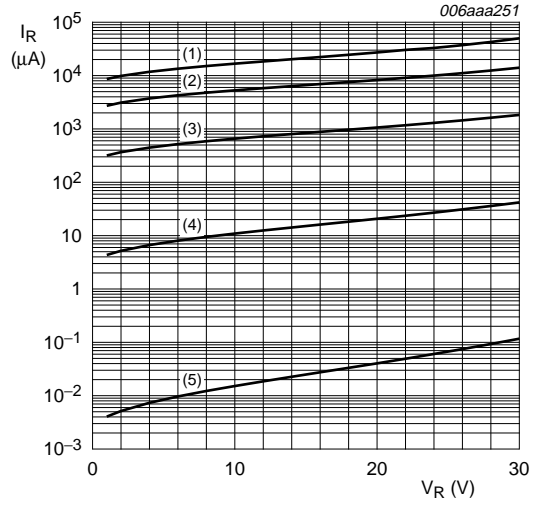

- (1) $T_{amb} = 150\text{ °C}$
- (2) $T_{amb} = 125\text{ °C}$
- (3) $T_{amb} = 85\text{ °C}$
- (4) $T_{amb} = 25\text{ °C}$
- (5) $T_{amb} = -40\text{ °C}$

Fig 5. PMEG3010EH, PMEG3010EJ: Reverse current as a function of reverse voltage; typical values

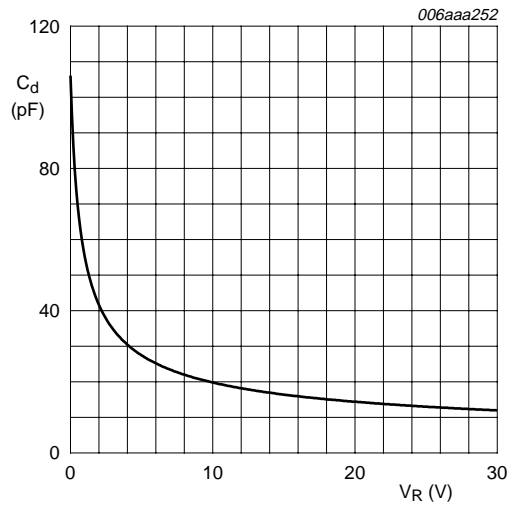

$T_{amb} = 25\text{ °C}; f = 1\text{ MHz}$

Fig 6. PMEG3010EH, PMEG3010EJ: Diode capacitance as a function of reverse voltage; typical values

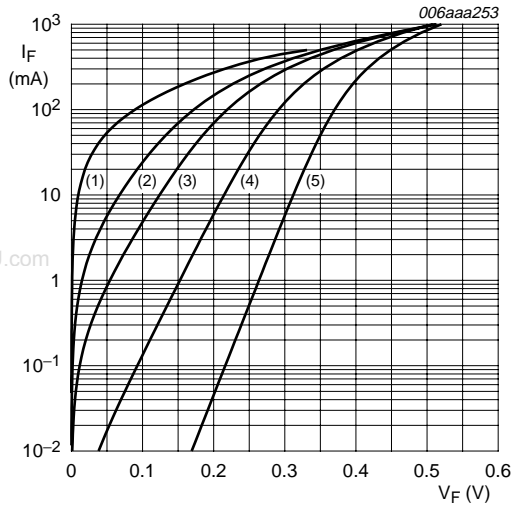

- (1) $T_{amb} = 150\text{ }^{\circ}\text{C}$
- (2) $T_{amb} = 125\text{ }^{\circ}\text{C}$
- (3) $T_{amb} = 85\text{ }^{\circ}\text{C}$
- (4) $T_{amb} = 25\text{ }^{\circ}\text{C}$
- (5) $T_{amb} = -40\text{ }^{\circ}\text{C}$

Fig 7. PMEG4010EH, PMEG4010EJ: Forward current as a function of forward voltage; typical values

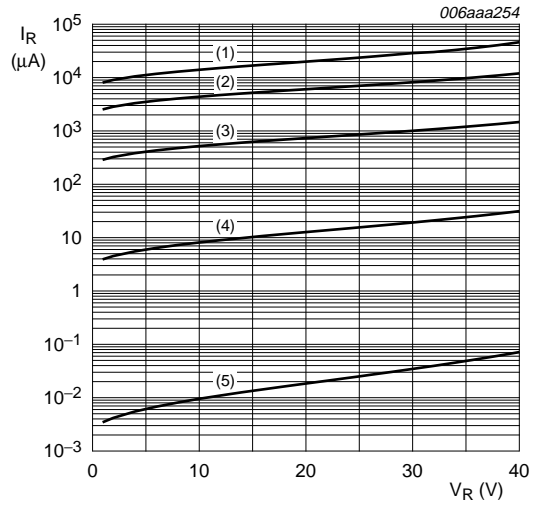

- (1) $T_{amb} = 150\text{ }^{\circ}\text{C}$
- (2) $T_{amb} = 125\text{ }^{\circ}\text{C}$
- (3) $T_{amb} = 85\text{ }^{\circ}\text{C}$
- (4) $T_{amb} = 25\text{ }^{\circ}\text{C}$
- (5) $T_{amb} = -40\text{ }^{\circ}\text{C}$

Fig 8. PMEG4010EH, PMEG4010EJ: Reverse current as a function of reverse voltage; typical values

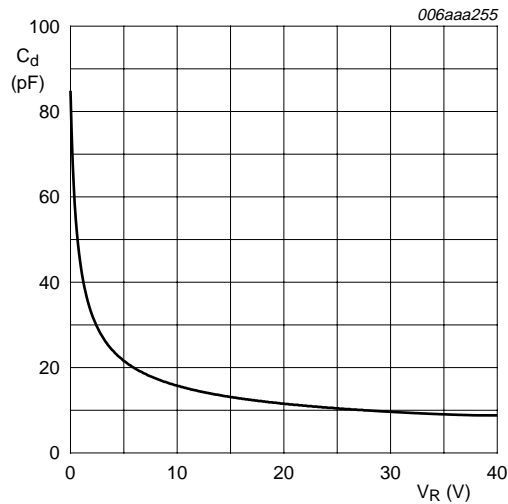

$T_{amb} = 25\text{ }^{\circ}\text{C}; f = 1\text{ MHz}$

Fig 9. PMEG4010EH, PMEG4010EJ: Diode capacitance as a function of reverse voltage; typical values

8. Package outline

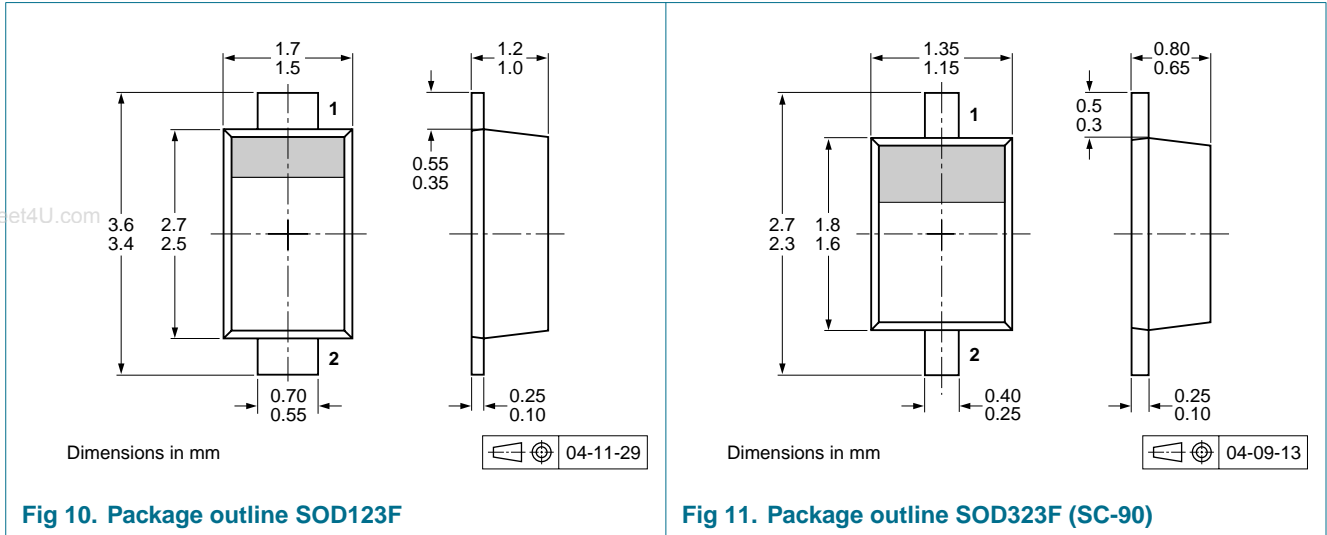

9. Packing information

Table 9: Packing methods

The indicated -xxx are the last three digits of the 12NC ordering code. [1]

Type number	Package	Description	Packing quantity	
			3000	10000
PMEGxx10EH	SOD123F	4 mm pitch, 8 mm tape and reel	-115	-135
PMEGxx10EJ	SOD323F			

[1] For further information and the availability of packing methods, see [Section 15](#).

10. Soldering

www.DataSheet4U.com

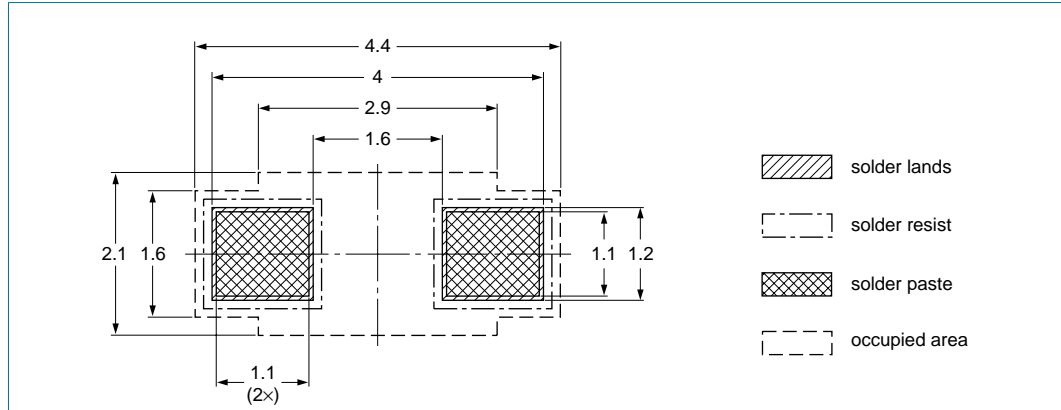

Reflow soldering is the only recommended soldering method.

Dimensions in mm

Fig 12. Reflow soldering footprint SOD123F

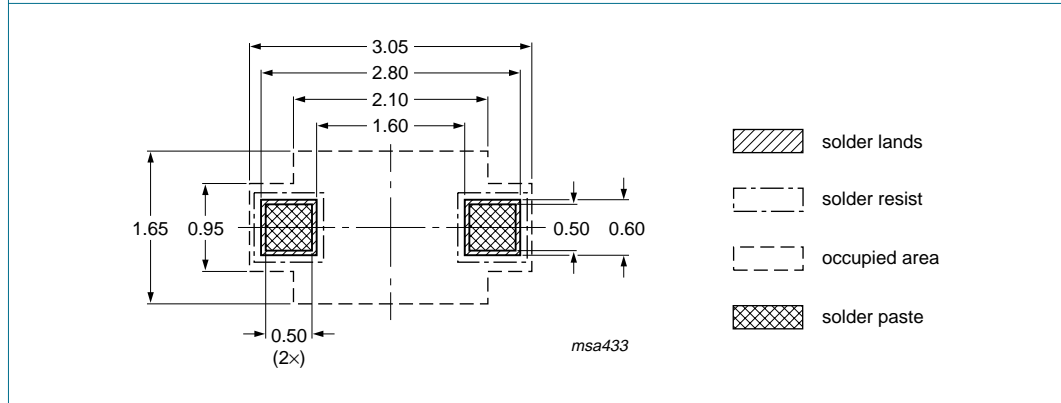

Reflow soldering is the only recommended soldering method.

Dimensions in mm

Fig 13. Reflow soldering footprint SOD323F (SC-90)

11. Revision history

Table 10: Revision history

Document ID	Release date	Data sheet status	Change notice	Doc. number	Supersedes
PMEGXX10EH_EJ_SER_3	20050411	Product data sheet	-	9397 750 14817	PMEGXX10EJ_SER_2
Modifications:					
			<ul style="list-style-type: none"> Types PMEG2010EH, PMEG3010EH, PMEG4010EH added Table 6 P_{tot} values for SOD323F added 		
PMEGXX10EJ_SER_2	20050131	Product data sheet	-	9397 750 14228	PMEGXX10EJ_SER_1
PMEGXX10EJ_SER_1	20040907	Objective data sheet	-	9397 750 13596	-

12. Data sheet status

Level	Data sheet status [1]	Product status [2] [3]	Definition
I	Objective data	Development	This data sheet contains data from the objective specification for product development. Philips Semiconductors reserves the right to change the specification in any manner without notice.
II	Preliminary data	Qualification	This data sheet contains data from the preliminary specification. Supplementary data will be published at a later date. Philips Semiconductors reserves the right to change the specification without notice, in order to improve the design and supply the best possible product.
III	Product data	Production	This data sheet contains data from the product specification. Philips Semiconductors reserves the right to make changes at any time in order to improve the design, manufacturing and supply. Relevant changes will be communicated via a Customer Product/Process Change Notification (CPCN).

[1] Please consult the most recently issued data sheet before initiating or completing a design.

[2] The product status of the device(s) described in this data sheet may have changed since this data sheet was published. The latest information is available on the Internet at URL <http://www.semiconductors.philips.com>.

[3] For data sheets describing multiple type numbers, the highest-level product status determines the data sheet status.

13. Definitions

Short-form specification — The data in a short-form specification is extracted from a full data sheet with the same type number and title. For detailed information see the relevant data sheet or data handbook.

Limiting values definition — Limiting values given are in accordance with the Absolute Maximum Rating System (IEC 60134). Stress above one or more of the limiting values may cause permanent damage to the device. These are stress ratings only and operation of the device at these or at any other conditions above those given in the Characteristics sections of the specification is not implied. Exposure to limiting values for extended periods may affect device reliability.

Application information — Applications that are described herein for any of these products are for illustrative purposes only. Philips Semiconductors make no representation or warranty that such applications will be suitable for the specified use without further testing or modification.

14. Disclaimers

Life support — These products are not designed for use in life support appliances, devices, or systems where malfunction of these products can reasonably be expected to result in personal injury. Philips Semiconductors customers using or selling these products for use in such applications do so at their own risk and agree to fully indemnify Philips Semiconductors for any damages resulting from such application.

Right to make changes — Philips Semiconductors reserves the right to make changes in the products - including circuits, standard cells, and/or software - described or contained herein in order to improve design and/or performance. When the product is in full production (status 'Production'), relevant changes will be communicated via a Customer Product/Process Change Notification (CPCN). Philips Semiconductors assumes no responsibility or liability for the use of any of these products, conveys no license or title under any patent, copyright, or mask work right to these products, and makes no representations or warranties that these products are free from patent, copyright, or mask work right infringement, unless otherwise specified.

15. Contact information

For additional information, please visit: <http://www.semiconductors.philips.com>

For sales office addresses, send an email to: sales.addresses@www.semiconductors.philips.com

16. Contents

1	Product profile	1
1.1	General description	1
1.2	Features	1
1.3	Applications	1
1.4	Quick reference data	1
2	Pinning information	2
3	Ordering information	2
4	Marking	2
5	Limiting values	3
6	Thermal characteristics	3
7	Characteristics	4
8	Package outline	8
9	Packing information	8
10	Soldering	9
11	Revision history	10
12	Data sheet status	11
13	Definitions	11
14	Disclaimers	11
15	Contact information	11



© Koninklijke Philips Electronics N.V. 2005

All rights are reserved. Reproduction in whole or in part is prohibited without the prior written consent of the copyright owner. The information presented in this document does not form part of any quotation or contract, is believed to be accurate and reliable and may be changed without notice. No liability will be accepted by the publisher for any consequence of its use. Publication thereof does not convey nor imply any license under patent- or other industrial or intellectual property rights.

Date of release: 11 April 2005
Document number: 9397 750 14817

Published in The Netherlands